

## ITALO

### PULSANTE-PUSH-BUTTON

ITA

**STRUTTURA:** Pulsante quadrato in inox e policarbonato/nylon;

**MONTAGGIO:** il pulsante viene inserito frontalmente tramite fissaggio a scatto in uno scasso da 32.5x32.5mm;

**SPESSORE PIASTRA:** da 0,7 a 3 mm;

**PARTE MOBILE:** in policarbonato con superficie esterna rivestita in acciaio INOX AISI 304 (possibilità di trattamento in PVD color oro o nero); cifra o decorazione in rilievo brunita e braille.

**COLLARINI:** in acciaio inox AISI 304 imbutito (con possibilità di trattamento PVD oro).

**CONTATTI:** 1 o 2 microswitch.

**CABLAGGIO:** connettori a vite o sistemi precablati(AMP o JST).

**ILLUMINAZIONE:** Led 12V o 24V DC 20mA.

**CORSA PULSANTE:** 1,2 mm.

**VITA MEDIA:**1.500.000 di attivazioni

**GRADO DI PROTEZIONE:** IP51.



ENG

**Body:** squared stainless steel and polycarbonate/nylon push button.

**Mounting:** the push button is put into the cutout (32.5x32.5mm) from the front and fixed by a snap fitting;

**Faceplate thickness:** 0.7mm to 3mm;

**Pressel:** polycarbonate with stainless steel AISI304 or gold/black PVD coated finishes; raised legend(s) and braille.

**Bezels:** deep drawn bezel in stainless steel AISI 304 (gold PVD coated is an optional)

**Contacts:** 1 or 2 microswitches;

**Wiring:** screws connectors or pre-wired connectors (AMP o JST);

**Illumination:** Led 12V or 24V DC 20mA

**Stroke:** 1,2 mm

**Lifetime:** 1.500.000 activations;

**Degree of protection:** IP51.

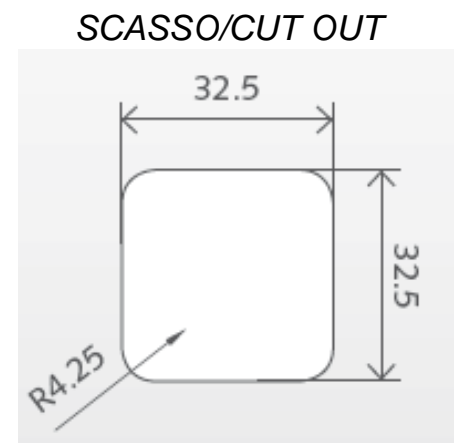
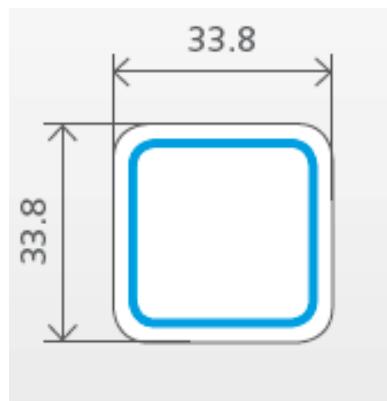
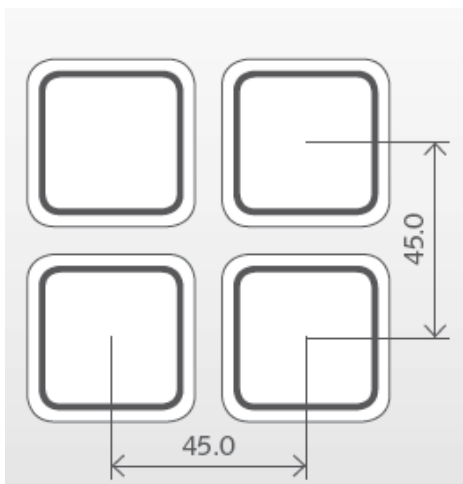

# VEGA

ITALIAN STYLE FOR LIFTS

## ITALO TH BLA

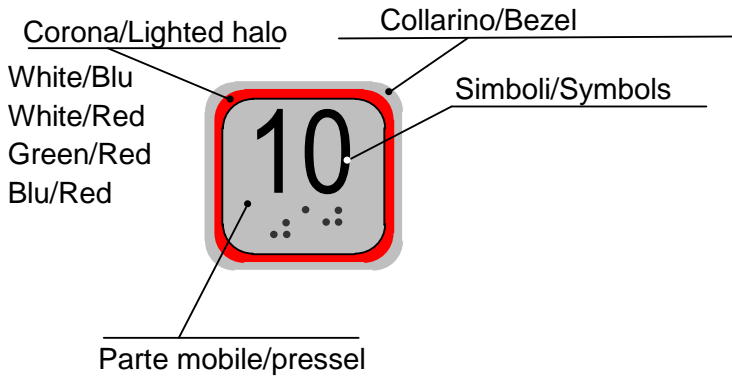

Connettore a vite/  
Screw connector

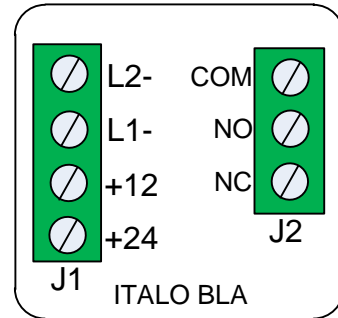

Schema di collegamento/  
wiring diagram

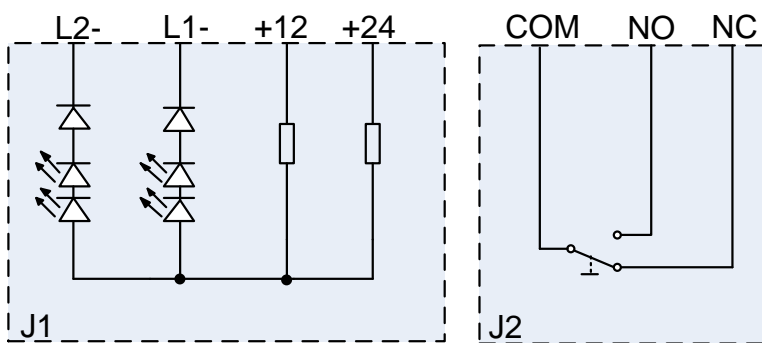

### J1

**+12:** Alimentazione +12Vdc / Power supply +12Vdc;  
**+24:** Alimentazione +24Vdc / Power supply +24Vdc;  
**L1-:** Corona 1 (-)/Lighted halo 1 (-);  
**L2-:** Corona 2 (-)/Lighted halo 2 (-);

### J2

**COM:** Comune contatto/Common contact.  
**NO:** contatto normalmente aperto/ normally open contact;  
**NC:** contatto normalmente chiuso/ normally closed contact;

## MONTAGGIO / ASSEMBLY



**1)** Inserire il pulsante frontalmente nell'apposito scasso. / Insert the push button into the cut out from the front.

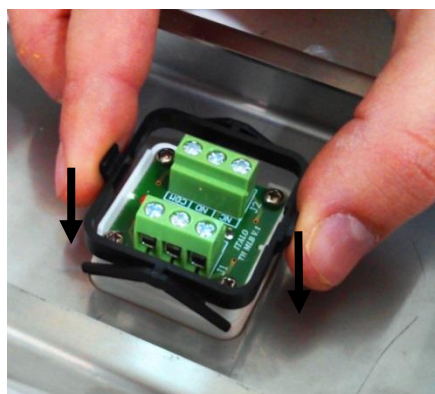



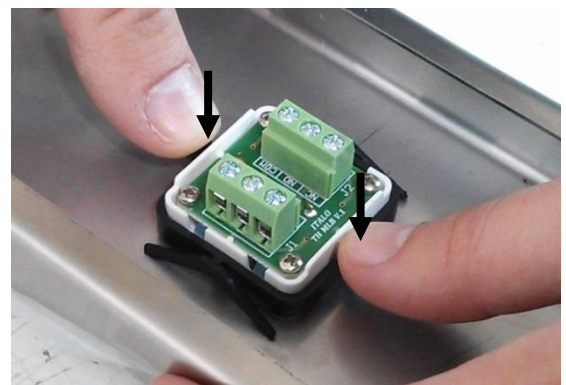











**2)** Inserire il sistema di fissaggio a scatto nel retro del pulsante come indicato in foto. / Insert the snap fixing system in the back side of the push button as indicated in the picture.



**3)** Infine effettuare una pressione sul sistema di fissaggio in modo che scatti con i dentini presenti sul corpo del pulsante. Il sistema va in flessione, arrivare al massimo. / At last make a pressure on the fixing system so that it engages with the teeth present on the body of push button. The system is flexible, push up at the most.

## SIMBOLI E LETTERING / SYMBOLS AND LETTERING

### Simboli/Symbols

< >		Apriporta/open door
> <		Chiudiporta/close door
F		Freccia/Arrow
TEL		Cornetta telefono /telephone handset
-4...32		Numeri/numbers [-4,-1,0...32]
S		STOP
N		Neutro/Neutral
F2		Doppia freccia/ Double arrow
V		Ventilatore/Ventilator
O		OTM
TLB		Cornetta telefono+Braille/ Telephon handset+Braille
INT		Interfono
A		Allarme/Alarm
AY		Allarme/Alarm

### Lettering

A	B
C	E
G	M
P	R
S	T
U	RJ
ES	DR
LG	CH
RC	UG
CP	LB
RB	SB
0H	1H
KG	K
SS	G1
MZ	G2

# LEGGERE ATTENTAMENTE LE AVVERTENZE SULLA PULIZIA !!!

I nostri pulsanti devono essere puliti solo ed esclusivamente con un  
PANNO IN COTONE E ACQUA CALDA !!!



Evitare qualsiasi utilizzo di sostanze chimiche, soprattutto per le  
superfici in plastica.

Molti prodotti Vega sono realizzati in policarbonato, ABS, metacrilato o nylon 66.  
L'utilizzo di prodotti di pulizia contenenti anche in minima parte ammoniaca,  
idrocarburi, soda caustica, acido cloridrico, acido nitrico, acido acetico, alcol etilico,  
alcol metilico sono assolutamente vietati.

\*\*\*\*\*

## CAREFULLY READ THE WARNINGS FOR CLEANING !!!

Our push buttons must be cleaned only and exclusively with a  
COTTON RUG and WARM WATER



Avoid every use of chemical substances, above all for plastic  
surfaces

Most of Vega products are made in polycarbonate, ABS, methacrylate or Nylon 66. The  
use of many cleaning products with caustic soda, hydrocarbons, hydrochloric acid, nitric  
acid, acetic acid, ethyl alcohol and methyl alcohol are strictly prohibited

# VEGA

## ITALIAN STYLE FOR LIFTS

VEGA STYLE LIFT s.r.l., Via Monte Vettore, 12 –

63845 Ponzano di Fermo (FM) Italy – P. Iva 02018560447

Tel. +39.0734.631941 – Fax: +39.0734.636098